

**Solar Inverters**

---

**INSTALLATION AND OPERATOR'S  
MANUAL**

---

## REVISION TABLE

Document Revision	Author	Date	Change Description
1.0	Falcon.Tang	30/08/2010	First release
			-



**SAVE THESE INSTRUCTIONS !**



**IMPORTANT SAFETY INSTRUCTIONS**

**JFY-tech:** Reproduction and disclosure of the contents of this manual are strictly forbidden without prior authorization of JFY-tech.

## **GENERAL PRECAUTIONS**

**For your own safety and that of the unit, you must read and understand the instructions contained in this document before starting to work.**

**Keep these instructions in a place accessible to all the personnel who work with the unit so that these may be consulted.**

**Only professional technician may install and operate our units.**

### **WARNING :**



To avoid risk of electric shock from energy stored in capacitor, please wait for at least 10 minutes to access the conductor part of input or output terminals of the inverter after it is disconnected from the output of PV panel and AC grid

There is a fuse in our units. For continued protection against risk of fire, replace only with same type and ratings of fuse. The replacement should be done by qualified service personnel.

- The installation of inverter must be performed in full compliance with the National Wiring Rules of Standard AS/NZS 3000 and other relative local standards and regulations.
- No spare parts in package box. To avoid risk of electric shock, Do not remove machine cover. No user serviceable parts inside. Refer servicing to qualified service personnel. Please contact your reseller if you need to know the nearest authorized repair center or qualified service personnel.
- As a qualified service personnel, you should know both ac and dc voltage sources are terminated inside this units. Each circuit must be individually disconnected before servicing.
- Read and understand all the instructions contained in this manual and become familiar with the safety symbols in the relevant paragraphs before you install and commission the equipment.
- The connection to the AC grid must be done only after receiving approval from the administering authority as required by national and state interconnection regulations, and can be done only by qualified personnel.
- Keep the whole surface of the photovoltaic panel covered with material opaque to solar radiation before connecting panel to equipment; this will ensure that no dangerous high voltage is present at the connection cables.
- This unit is designed to feed power to the public power grid (utility) only. Do not connect this unit to an AC source or generator. Connecting Inverter to external devices could result in serious damage to your equipment. By the way, we have special types for these applications. If you are interested, please contact your local dealer.
- Although designed to meet all safety requirements, some parts and surfaces of Inverter are still hot during operation. To reduce the risk of injury, do not





touch the heat sink at the back of the solar inverter or nearby surfaces while Inverter is operating. By the way, keep it away from any flammable objects.

- This version of JSI inverters shall be used with panels connected in a “floating” way, i.e. with positive and negative terminal not connected to the ground.

The equipment is provided with several labels, some of them with a yellow background, which are related to safety issues.

Make sure to read the labels and fully understand them before installing the equipmnt.

The symbols are:

	Equipment grounding conductor (Main grounding protective earth, PE)
	Alternate Current (AC) value
	Direct Current (DC) value
	Phase
	Grounding (Earth)

# CONTENT

<b>1. OVERVIEW</b> .....	6
<b>2. INSTALLATION</b> .....	8
2.1 Package inspection .....	8
2.2 Selecting the place of installation .....	8
2.3 Fixed on the wall .....	9
2.4 System diagram and connection label .....	10
2.5 Connecting to the AC grid (utility) .....	12
2.6 Connect to PV Panel (DC input) .....	12
<b>3. CONTROL PANEL FUNCTIONS</b> .....	13
3.1 Operate the Function Key .....	13
3.2 General LCD Display Information .....	15
<b>4. INVERTER START-UP AND OPERATION</b> .....	16
<b>5. COMMUNICATIONS</b> .....	17
5.1 Data communications with RS232 .....	17
5.2 Data communications with RS485 .....	17
5.2.1 RS485 Serial Port.....	17
5.2.2 RJ45 Connectors.....	18
5.2.3 RS485 Daisy Chain.....	19
5.3 Monitor Inverter.....	20
<b>6. MAINTENANCE</b> .....	20
<b>7. TROUBLE SHOOTING</b> .....	21
<b>8. SPECIFICATIONS</b> .....	22
<b>9. JFY-tech WARRANTY</b> .....	24
<b>10. JFY-tech CONTACT INFORMATION</b> .....	26

# 1. OVERVIEW

## 1.1 Machine Overview

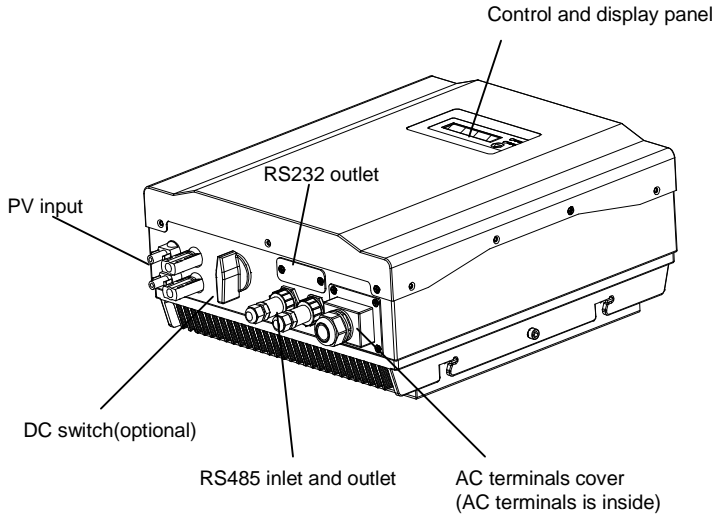

Front View

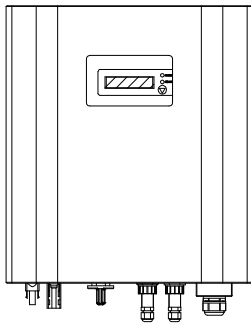

Bottom View

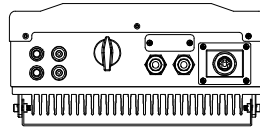

Fig.1 Overviews of inverter

### Opening the package

After opening the package, please check the contents of the box. It should contain the following accessories:

Item	Name	Quantity
1.	Solar inverter	1pcs
2.	Mounting frame	1pcs
3.	Mounting screws and blocks	6pcs
4.	Safety-lock screws	2pcs/4pcs
5.	Socket head wench	1pcs
6.	DC socket assembly	1set
7.	AC socket assembly	1set
8.	RS-485 sockets, one with 120 ohm terminal resistor	2pcs
9.	Special RS-232 cable	1pcs
10.	Instruction manual	1pcs
11.	Monitor software(CD)	1pcs
12.	Warranty sheet	1pcs

**JSI-xxxxTL series include JSI-2000TL, JSI-2000TL-S, JSI-3000TL, JSI-3000TL-S, JSI-5000TL, JSI-5000TL-S JSI-6000TL and JSI-6000TL-S. The -S suffix indicates the inverter with an integrated DC switch.**

## 2. INSTALLATION



**WARNING:** The electrical installation of JSI inverter must be performed in compliance with applicable local and national standards and laws.



**WARNING:** The connection of JSI inverter to the AC grid must be performed only after receiving authorization from the utility that operates the grid.

### 2.1 Package Inspection

The customer is encouraged to perform the following checks:

- Inspect the package box for apparent damage, such as holes, cracking or any sign of possible damage to its contents.
- Describe any damage or shortage on the receiving documents and have the carrier sign his/her full name.
- Open the package box and inspect the contents for internal damage. While unpacking, be careful not to discard any equipment, parts or manuals. If any damage is detected, call the delivering carrier to determine the appropriate action. Save all shipping material for the event the carrier sends an inspector to verify damage!
- If the inspection reveals damage to the inverter, please call your local supplier or the authorized distributor. They will determine if the equipment should be returned for repair. They will also provide instructions on how to get the equipment repaired;
- It is the customer's responsibility to file a claim with the carrier. Failure to file a claim with the carrier may void all warranty service rights for any damage;
- Carefully store the original packaging of JSI inverter since it shall be used in case it is necessary to ship it for repair.

### 2.2 Selecting the place of installation

Place of installation should be selected based on the following considerations:

- JSI inverters shall be set at a suitable height from the ground to enable easy readout view of the display and the LEDs.
- Select a well ventilated place sheltered from direct sun radiation. Choose a place that allows fluent air flow around the unit.
- Allow sufficient room around the unit to enable easy installation and removal of the object from its mounting surface.

The following figure shows the recommended minimum clearances around the inverter:



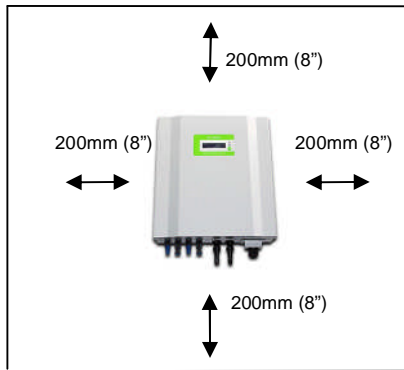

Fig.2 Installing minimum clearances around inverter

## 2.3 Fixed on the wall

Step1: Drill 6 or 9 holes as illustrated in the Fig.3

Step2: Fix the mounting frame as illustrated in the Fig.4 by the screws, then, hang the inverter on the mounting frame.

Step3: Fix safety-lock screws at left side and right side as illustrated in Fig.5 with the attached socket head wrench.

Step4: Check the installation conditions.

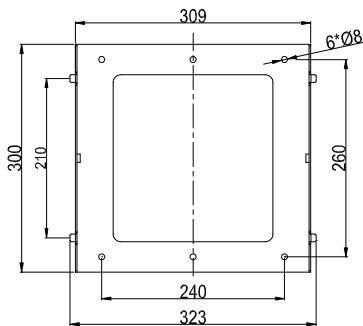

For JSI-2000TL/-S and JSI-3000TL/-S

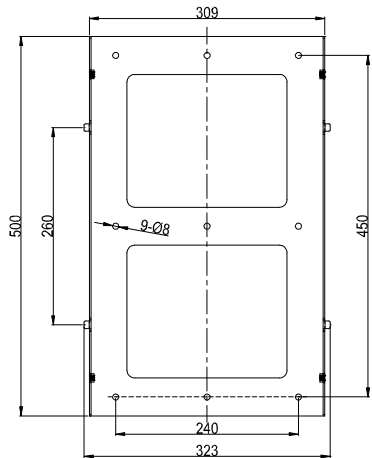

For JSI-5000TL/-S and JSI-6000TL/-S

Fig.3 The size of mounting frame

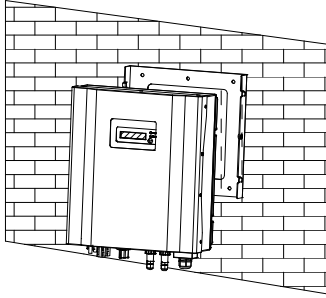

Fig.4 Hang inverter to mounting frame

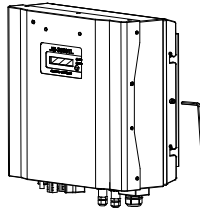

Fig.5 Fix safety-lock screws

The customer is encouraged to perform the following checks:

- Do not install the solar inverter on a gradient surface.
- Check the upper straps of solar inverter and ensure it to fit on to the bracket.
- Ensure safety-lock screws (M5 socket head cap screws) to insert into the mounting frame through inverter's heatsink.
- Check the secure mounting of the solar inverter by trying to raise it from the bottom. The solar inverter should remain firmly attached.
- Choose a strong mounting wall to prevent vibrations while inverter is operating.

## 2.4 System Diagram and Connection Label

The JSI series are a single phase solar inverters. They are responsible for converting the direct current generated by PV panels into single-phase 230Vac 50Hz alternating current for delivery into the AC grid.

The JSI series can be used in an on-grid PV system to produce electricity.

The installation of the JSI series and their connection to the AC grid shall be done in accordance with local regulations and may require the installation of adequate electricity consumption measuring devices.

The JSI series only operates when it is connected to the AC grid and can not operate as a stand-alone unit.

The simplified connection diagram of the inverter is as follows.

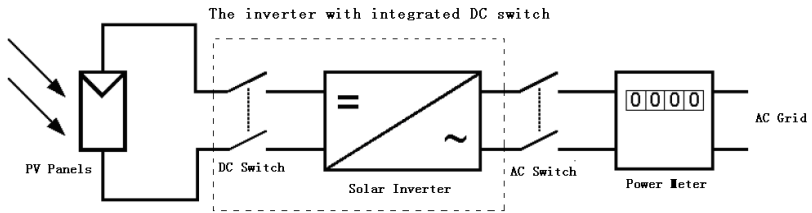

Fig.6 The PV system diagram

- A. PV Panels: Provide DC power to inverter.
- B. Solar inverter: Converts DC (Direct Current) power from PV panel(s) to AC (Alternating Current) power. Because Inverter is grid-connected it controls the current amplitude according to the PV Panel power supply. Inverter always tries to convert the maximum power from your PV panel(s).
- C. DC Switch and AC Switch: “DC switch” is between PV Panels and solar inverter while “AC Switch” is between AC Grid (Utility) and solar Inverter. They are simplified in this diagram. In fact, they may consist of electrical breaker, fuse and connecting terminals. To comply with local safety standards and codes, the connection system should be designed and implemented by a qualified technician. JFY-tech also provides the solar inverter with an integrated DC switch demonstrated in dashed border in Fig.6. –S suffix indicates the inverter is integrated a DC switch in PV input side.
- D. AC Grid (Utility): Referred to as “grid” in this manual, is the way your electric power company provides power to your place. Please note that Inverter can only connect to low-voltage systems (namely, 220/230Vac, 50Hz).

**Note:** JFY-tech provides an integrated switch box that includes DC switch, AC switch, DC fuse, AC fuse, DC SPD and AC SPD devices as an option. Of course, you can get similar switch box from your local market.



Fig. 7 Connections available on inverter bottom and relevant marking

- E. PV INPUT: Connected to PV Panels by MC4 terminals.
- F. RS232: Connected to monitoring computer by special RS232 cable provided by JFY-tech.
- G. RS485: daisy-chain communication for one or more inverters.
- H. AC TERMINAL (three blocks in right hand): Connected to AC Grid.

## 2.5 Connecting to the AC Grid (Utility)

- A. Measure AC grid (utility) voltage and frequency. It should be 230VAC (or 220VAC), 50Hz and single phase.
- B. Open AC Switch between solar inverter and AC Grid (Utility).
- C. Open AC terminals cover and connect AC wires on AC terminals as follows:



Fig. 8 AC terminals under AC terminals cover

Recommended AC wires			
Model	Diameter(mm)	Cross Area(mm <sup>2</sup> )	AWG no.
JSI-2000TL JSI-3000TL	2.05	3.31	12
JSI-5000TL JSI-6000TL	2.59	5.27	10

## 2.6 Connect to PV Panel (DC input)

- A. **Under any condition!** Make sure the maximum open circuit voltage (Voc) of each PV string is less than 550VDC for JSI-6000TL and JSI-5000TL, less than 500VDC for JSI-2000TL and JSI-3000TL. The length of input wire must be less than 30m. By the way, generally, in the lowest ambient temperature of your installing field, the Voc of PV string is the highest.
- B. Use MC4 (Multi-contact) connectors for PV array terminals.
- C. Open DC Switch and Connect the positive and negative terminals from the PV panel to DC switch, then to positive (+) terminals and negative (-) terminals on the solar inverter. Each DC terminal on inverter can withstand 20Adc.
- D. When connecting PV panels to DC Switch, then, DC Switch to the terminals of inverter, please make sure the polarity is correct.  
**Incorrect polarity connection could permanently damage the unit.**

Please confirm short-circuit current of the PV string. The total short-circuit current of the PV string should be less than the inverter's maximum DC input current.

- E. High voltages exist when the PV panel is exposed to the sun. To reduce risk of electric shock, avoid touching live components and treat connection terminals carefully.

**Note:** Ensure that photovoltaic field voltage polarity matches the “+” and “-” symbols. Before connecting JSI inverters with the photovoltaic field, JFY-tech recommends to check, using a proper gauge, that the polarity value and the voltage allowed value between positive and negative contacts are correct.

### 3. CONTROL PANEL FUNCTIONS

There is an LCD screen, two LEDs and one function key on the front of the solar inverter. The LCD and LED provide you with details of the status of your Inverter. You also can use this Function key as a simple control.

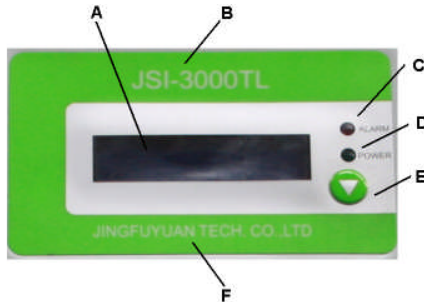

Fig. 9 Control panel

- A. LCD Screen: Display the operating data and situations, warning/error codes and information.
- B. The model of inverter (for example,JSI-3000TL)
- C. ALARM LED: Indicates the fault of inverter.
- D. POWER LED: Indicates the inverter is running normally.
- E. Function Key: Used to set different parameter and display language for the inverter.

**Note:** To save power, the LCD display's backlight automatically turns off after 30 seconds.

#### 3.1 Operate the Function Key

To view the the operating data of the inverter, you can press the Function Key. Of course, the data also will automatically and periodically display. To set different

display contrast and display language for the inverter, please carefully refer to the following chart.

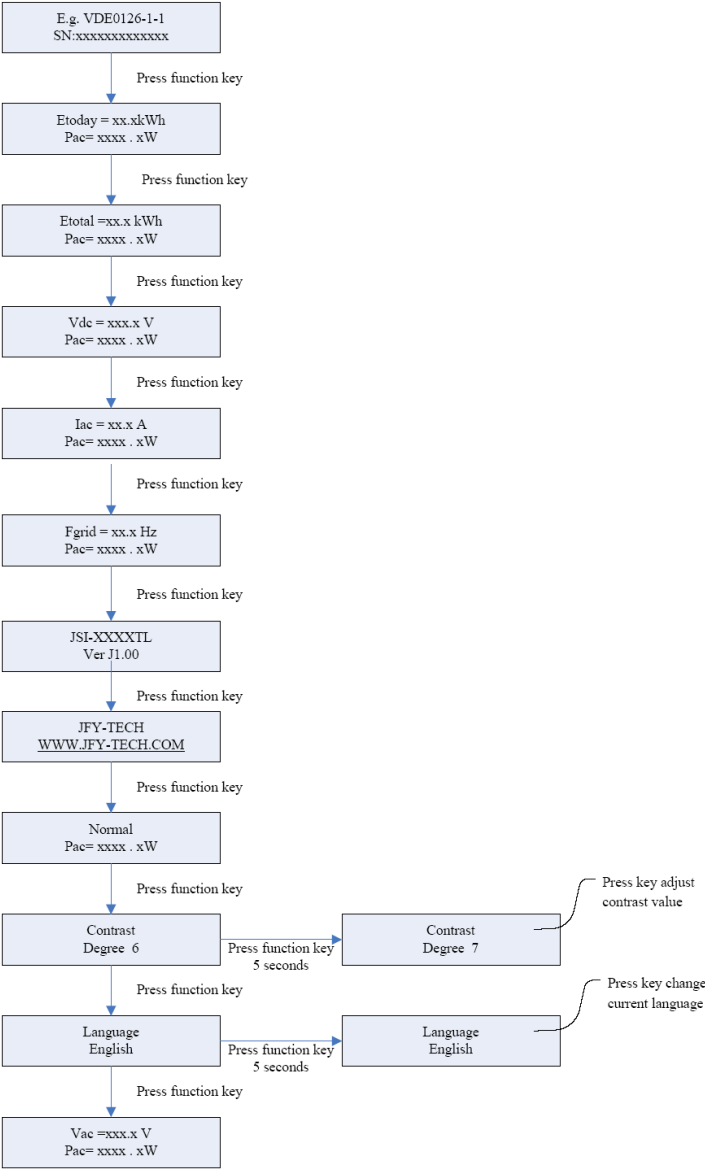

To lockup or unlock display message as follows:

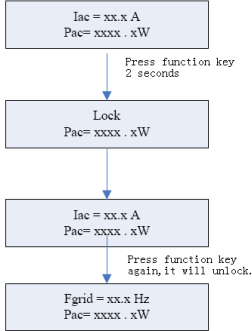

### 3.2 General LCD Display Information

State Message In LCD		
STATE	DISPLAY CONTENT	COMMENTS
Wait State	Standby	PV input voltage low
	Waiting	Initial waiting
	Connect in xxS	System checking
	Reconnect in xxS	System checking
Inverter connection State	Connect OK	Connect to Grid
Fault State	Exx	System error code
	Wxx	System warning code
Auto Test State	Auto Testing	Protection auto test
Program State	Programming	Update Software

Main Operating Messages In LCD		
STATE	DISPLAY CONTENT	COMMENTS
Normal Operation	JFY-TECH	Abbr. company name
	WWW.JFY-TECH.COM	JFY-TECH's website
	JSI-xxxTL	The inverter model
	Ver Jx.x	The FW version
	SN: xxxxxx	The Serial Number
	Etoday = xx.xkWh	The energy today
	Ettotal = xxxkWH	The total energy in lifetime
	Pac = xxx.xW	The output power of inverter
	Iac = xx.xA	The output current of inverter
	Vac = xxx.xV	The grid voltage

Fgrid = xx.xHz	The grid frequency
Vdc=xxx.xV	The PV input voltage
VDE0126-1-1	Comply with main standard
English	Current selected language
Contrast x	LCD Contrast
Fgrid = xx Hz	The grid frequency

## 4. INVERTER START-UP AND OPERATION



### WARNING:

Do not place any items on JSI inverter during operation.

When the inverter is operating, do not touch the heat sink since some parts may become very hot.

**Step 1:** Ensure that the AC cable and DC cable is connected correctly, unused DC plugs and AC terminal cover are sealed.

**Step 2:** Connect the DC and AC switches. The inverter starts up automatically when DC-power from the PV strings is sufficient.

Once the solar inverter starts, it enters one of the following 3 states in turn:

Standby: The PV string can only provide just enough voltage to minimum requirements of the internal controller unit.

Waiting: When the PV string DC voltage is greater than 100V, The inverter enters a “waiting” state and attempts to connect to the grid.

Normal: When PV string DC voltage is greater than 150V, Inverter operates in the normal state.

The Inverter will keep MPPT function and deliver power to AC Grid when it is in normal operation. Maybe it will stop under the situation of low input DC-power, Don't worry, it will automatically restart again when DC-power from the PV string is sufficient.

### Error or Warning status

Inverter is designed to be user-friendly, therefore, the error or warning status of the Inverter can be easily understood by reading the information shown on the front panel display. All possible messages are shown in the following table.

DISPLAY	COMMENTS
<b>System fault</b>	
Auto Test Failed	Auto Test does not pass
W01 No grid	No Utility, No Grid Connect
W02 Vin overvoltage	PV panel Voltage is too high
E01 Isolation error	Insulation Problem of PV panel



E02	Ileak error	GFCI Fault, leakage current is too high
E03	Grid fault	Grid voltage/frequency is out of range
<b>Inverter fault</b>		
E04	Coherence error	Consistent Fault
E05	Over temperature	Internal temperature abnormal
E06	Relay failure	Output relay Fault
E07	DCinj failure	Output Current DC Offset too high
E08	EEPROM failure	EEPROM Fault
E09	Com. failure	Communication Fault
E10	DC bus OV.	DC Bus over-voltage
E11	DC bus UV.	DC Bus under-voltage
E12	Vref error	2.5V Reference Voltage Fault
E13	DC sensor fault	DC current sensor fault
E14	GFCI failure	GFCI Device is damaged

## 5. COMMUNICATIONS

### 5.1 Data communication with RS232



Fig. 10 RS232 serial port and special RS232 cable

Open the cover of RS232 serial port, Connect solar Inverter and computer by JFY-tech special RS232 cable. By the way, the communication distance should be below 10m.

**NOTE:** Only JFY-tech special RS232 cable can work. If its length is not enough, you can buy “extended RS232 cable” in local market.

### 5.2 Data communication with RS485

#### 5.2.1 RS485 Serial Port

The RS485 is used for several inverters' communication. Ethernet cable is applied to connect each inverter herein. Only three cables in ethernet cable: two signal ones and one for ground connection.



Fig. 11 The waterproof RJ45 socket and connectors for RS485 port

To help installation, the inverter features two RJ45 sockets to separate input ethernet cable from output ethernet cable.

### 5.2.2 RJ45 Connectors

The RS485 serial connection, whether single unit or several inverters as daisy chain, can be performed by means of the RJ45 connectors (See Fig. 11).

It makes no difference if its sockets is no.1 or no.2 since they are connected in parallel, and signals are thus the same. One socket is for input ethernet cable with RJ45 connector, another socket is for output ethernet cable with RJ45 connector. The output ethernet cable reaches the following unit.

RS485 pin definition is as follows:

RJ45 connectors			
<p>T-568B</p> <p>Clip is pointed away from you.</p>	<b>Pin #</b>	<b>Signal Name</b>	<b>Description</b>
	1		Not Used
	2		Not Used
	3	<b>RTN</b>	<b>Signal Return</b> Common reference for logical signals.
	4		Not Used
	5		Not Used
	6		Not Used
	7	<b>-TR</b>	<b>- Data Line</b> Required for RS485 communication.
8	<b>+TR</b>	<b>+ Data Line</b> Required for RS485 communication.	

**NOTE:** You can buy T-568B standard Straight-Through ethernet cable to connect two adjacent inverters in local market. Of course, you can do it by yourself and remember the ethernet cable is Straight-Through.

### 5.2.3 RS485 Daisy Chain

RJ45 connectors may be used to connect a single JSI inverter or multiple JSI inverters daisy chained together. Up to 31 inverters can be daisy chained. Recommended maximum daisy chain length is 1000m.

With multiple daisy-chained inverters, each unit will be automatically assigned a RS485 address with JFY monitoring software.

The RJ45 socket with 120Ω terminal resistor should be installed at the last inverter in the chain. JFY-tech provide a special RJ45 socket with terminal resistor and a vacant RJ45 socket in the attached accessories. When the inverter is not the last one in the chain, please draw out the terminal resistor and use it as a vacant RJ45 socket.

In order to ensure that the communication on the RS485 line is very safe, JFY-tech recommends connecting an isolating RS232-485 adapter between the first inverter in the daisy chain system and the computer. Of course, non-isolating RS232-485 adapter can also work.

The following diagram shows how to connect multiple inverters in a daisy chain configuration.

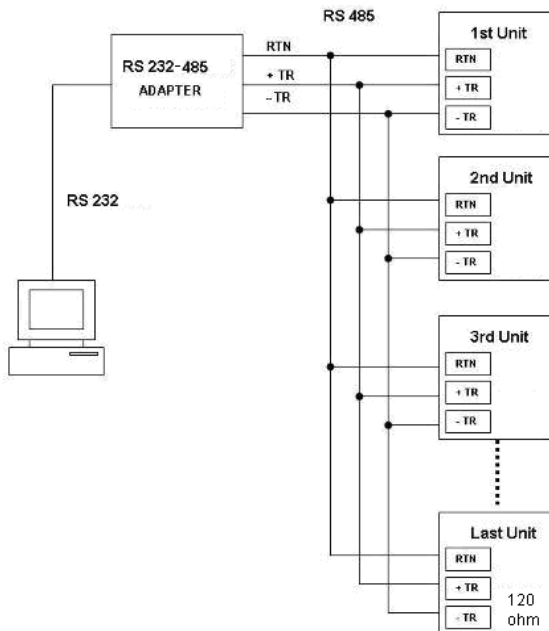

Fig.12 Multiple daisy-chain connection

**NOTE:** The RS485 link supports up to 31 inverters.

**NOTE:** The RJ45 socket with  $120\Omega$  terminal resistor should be installed at the last inverter in the chain. Even if there is only one inverter, the  $120\Omega$  terminal resistor is also necessary.

## 5.3 Monitor Inverter

After RS232 or RS485 link is connected correctly, open JFY monitoring software "JFY communicator" that is installed from the attached CD, the user can monitor the inverters. The right side of the main interface is the detailed information of inverter. As to more detailed setting methods and other functions, please refer to "JFY communicator user's manual" in the CD.

## 6. MAINTENANCE

The inverter is maintenance-free. Take it easy for its daily operation.

## 7. TROUBLE SHOOTING

In most situations, the Inverter requires very little service. However, if Inverter is not able to work perfectly, please refer to the following instructions before calling your local dealer or service personnel.

If any problems arise, the “Alarm” LED on the front panel will be red and the LCD displays the relevant information. Please refer to the following table for a list of potential problems and their solutions.

DISPLAY		HOW TO DO?
No any display in LCD or LED		Check PV-input connections
W01	No grid	Check grid connection cables.
W02	Vin overvoltage	Check the Voc of PV string, see if it is greater than or too close to max. input DC voltage of relative inverter type.
E01	Isolation error	Check the impedance is between PV (+) & PV (-) and the PV-Inverter is earthed. The impedance must be greater than 2MΩ
E02	Ileak error	The leakage current is too high. Unplug the inputs from the PV string and check the peripheral AC system.
E03	Grid fault	Make sure grid voltage and frequency meet the specifications

**NOTE:** During periods of little or no sunlight, the solar inverter may continuously start up and shut down. This is due to insufficient power generated to operate the control circuits, not a trouble.

**If you can not solve the trouble with above procedures, Please contact your local dealer or service personnel.**

Before contacting the authorized local dealer or service personnel, please find and keep at hand the following information:

**Information of JSI inverter**

1. Inverter Model
2. Serial Number
3. Week of manufacture
4. Which LED is red?
5. Which warning/error is displayed?
6. Do you notice whether warning/error can be repeated?

**Information of the PV array**

1. The model and manufacturer of the PV panels
2. Number of strings in the PV array and number of panels per string

## 8. SPECIFICATIONS

Model Parameter	JSI-2000TL JSI-2000TL-S	JSI-3000TL JSI-3000TL-S
<b>Input Data</b>		
Max. DC power	2300W	3550W
Max. DC voltage	500V	500V
MPPT operating voltage range	100V-450V	100V-450V
Number of parallel inputs	1	2
Number of MPP trackers	1	1
Max. input current (total)	10A	20A
<b>Output Data</b>		
Nominal AC output power	2000W	3000W
Max. AC power	2200W	3400W
Max. output current	10.5A	15.7A
AC grid voltage range	206~264Vac	206~264Vac
AC grid frequency range	49.25~50.75Hz	49.25~50.75Hz
Power factor (cos $\phi$ )	>0.99	>0.99
THDI(at nominal output power)	<3%	<3%
AC connection	Single phase	Single phase
Max. efficiency	>96%	>96%
Euro efficiency	>95%	>95%
MPPT efficiency	>99 %	>99%
<b>General Data</b>		
Dimensions (W /D/ H) in mm	345/162/354	345/162/384
Weight	15Kg	17Kg
Operating temperature range	-25 °C ~+60 °C	-25 °C ~+60 °C

Model Parameter	JSI-5000TL JSI-5000TL-S	JSI-6000TL JSI-6000TL-S
<b>Input Data</b>		
Max. DC power	5300W	6400W
Max. DC voltage	550V	550V
MPPT operating voltage range	100V-550V	100V-550V
Number of parallel inputs	2	2
Number of MPP trackers	1	1
Max. input current (total)	22.5A	27.5A
<b>Output Data</b>		
Nominal AC output power	4600W	6000W
Max. AC power	5000W	6000W
Max. output current	24A	31.2A
AC grid voltage range	206~264Vac	206~264Vac
AC grid frequency range	49.25~50.75Hz	49.25~50.75Hz
Power factor (cos $\phi$ )	>0.99	>0.99
THDI(at nominal output power)	<3%	<3%
AC connection	Single phase	Single phase
Max. efficiency	>97%	>97%
Euro efficiency	>96%	>96%
MPPT efficiency	>99%	>99%
<b>General Data</b>		
Dimensions (W /H/ D) in mm	345/162/573	345/162/573
Weight	26Kg	26Kg
Operating temperature range	-25 °C ~+60 °C	-25 °C ~+60 °C

## 9. JFY-tech WARRANTY

Warranty Policy:

**Warranty Period:** The JSI Series PV Grid-tied inverters provided by Shenzhen JingFuYuan Tech. Co., LTD. (abbr. JFY-tech) have 60-month warranty period. The system accessories provided by JFY-tech have 24-month warranty period.

**Warranty Time Start:** From the date that you get goods from our distributors.

**Warranty Evidence:** The Purchasing Invoice from the distributors & Product Series No.

**Note:** JFY-tech will count from 2 months later according to ex-factory date as the warranty start time if client fails to provide the purchasing invoice and other documents.

**Scope:** Any damages that occur during the WARRANTY PERIOD will be evaluated by Distributor and JFY-tech to define its scope and responsibility.

Warranty Principles:

To provide better service to JFY-tech's end users, all JFY-tech's authorized distributors are requested to respond to end users' warranty claim, and the authorized distributors will replace any products or parts of the product during the warranty period proved to be defective in design or manufacture. The following cases will be excluded from the warranty (the Distributors are liable for investigation of the following):

- 1) "Warranty Card" not being sent back to distributor or JFY-tech.
- 2) Product modified or design changed or parts replaced not approved by JFY-tech.
- 3) Modifications, changes, or attempted repairs and erase series number or seals by non JFY-tech's technician.
- 4) Incorrect installation or commissioning
- 5) Failure to observe the applicable safety regulations (VDE standards, etc.)
- 6) The Product has been improperly stored and damaged while being stored by the end user.
- 7) Transport damage, Painting scratch caused by shipping pumping. It should declare to insurance company as soon as containers unload with enough evidence.
- 8) Failure to observe the user manual, the installation guide, and the maintenance regulations
- 9) Incorrect use or inappropriate operation
- 10) Insufficient ventilation of the device
- 11) The maintenance procedures relating to such product have not been



observed or performed to an acceptable standard.

12) Force majeure (e.g., lightning, overvoltage, storm, fire)

Claims that go beyond the rights cited in the warranty principles, in particular claims for compensation for direct or indirect damages arising from the defective device, for compensation for costs arising from disassembly and installation, or loss of profits are not covered by JFY-tech's warranty, insofar JFY-tech is not subject to statutory liability.

#### Warranty Claim Procedure:

Please report defective devices with a brief error description to the JFY-tech's distributors. If we agree to a replacement, we generally send an equivalent replacement device according to model and age, the remainder of the warranty entitlement will be transferred to the replacement device. In this case, you do not receive a new certificate since your entitlement is documented at JFY-tech. The replacement will be packaged appropriately for transport and shipped out within 2 working days. The defective device is to be packed in this transport packaging for return transport to the distributor. If the on-site service of re-installation is necessary, the end customers need to negotiate with the distributors in advance. All warranty services in warranty period are free of charge.

## **10. JFY-tech CONTACT INFORMATION**

Shenzhen JingFuYuan Tech. Co., LTD.

ADD: 5<sup>th</sup> Floor ,12<sup>th</sup> Block ,Nangang Second Industrial Park ,Nanshan District ,Shenzhen ,P.R.China

Tel: +86-755-26632536

Fax: +86-755-26505986

Email: [support@jfy-tech.com](mailto:support@jfy-tech.com)